WHITE PAPER

High Voltage GaN Switch Reliability

Ronald Barr et al.

November 2018

transphorm

Highest Performance, Highest Reliability GaN

High Voltage GaN Switch Reliability

Calculation of FIT rates and PPM reliability based on existing JEDEC, AEC and ZVEI Standards

Ronald Barr, Jeff Haller, Ken Shono, Elena Georgieva, Jim McKay, Peter Smith, Rakesh Lai, Yifeng Yu, Kurt Smith
Transphorm Inc., Goleta, California/USA, rbarr@transphormusa.com

Abstract— Adoption of any semiconductor technology by the power conversion market requires an understanding of fundamental failure modes, acceleration factors, and reliability statistics. In this paper we will show how GaN products from Transphorm can meet this challenge, especially in the critical High Voltage Off State (HVOS) reliability stress test. The anticipated failure rate during a product's first 10 to 20 years of use is of particular interest as it has direct impact on warranty costs. This requires an understanding of both extrinsic and intrinsic failure rates. This market requirement can be addressed by testing to failure statistically significant samples of devices, and analyzing the data, with appropriate models. This paper will discuss the methods developed for measuring GaN reliability on large samples which are wholly based on existing industrial and automotive standards. Further, the paper will discuss how the resulting data can be used to supplement qualification testing results when the failure modes and acceleration factors are well understood.

Keywords—GaN, reliability, power electronics, HEMT, FIT, acceleration factor, PPM

I. INTRODUCTION

Transphorm has created a body of reliability data across multiple generations of products that demonstrate the robustness of their platform; by extensive qualification testing, testing to device failure, and by having an in depth understanding of failure modes and acceleration factors.

There are a set of comprehensive standards to provide guidance to producers and users of wide band gap devices to determine if product reliability will meet application reliability requirements. These standards are not “new” and are routinely used in the automotive industry and by extension to commercial applications to determine product lifetime and robustness [3]-[8]. By properly applying these standards to develop reliability tests and making the data readily available one can provide assurance that products being produced will meet the reliability requirements of commercial and automotive applications.

In this paper will discuss the application of accelerated life test data to determine the intrinsic and extrinsic failure rates of a commercially available automotive qualified GaN device from Transphorm.

II. DEVICE DESCRIPTION

Unless otherwise noted the device used in this paper is the TPH3205WSQA produced by Transphorm Incorporated, located in Goleta California. [9]. This is a normally off, two chip design with a D mode GaN HEMT in series with a

normally off low voltage silicon FET. $V_{ds(min)}=650V$, $V_{(TR)DSSmax}=800V$, $R_{ds(on)max}=62m\Omega$, TO247 package. This part has been qualified to the Q101 standard.

Figure 1: Cross Section of GaN HEMT

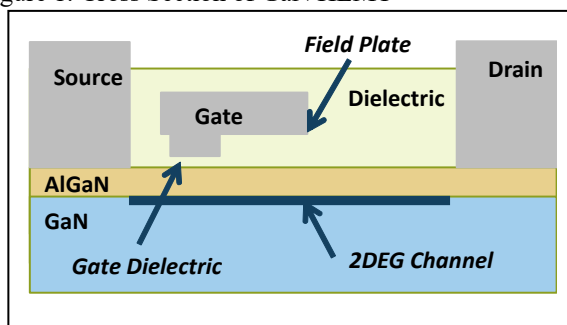

III. HIGH TEMPERATURE REVERSE BIAS: OFF STATE FAILURE MODE AND ACCELERATION FACTORS

Failure mode determination and acceleration factor analysis was presented at ROCS 2017 [10] in detail and will be summarized in this section. High temperature reverse bias off state testing has historically been a difficult test for GaN devices to pass. The reason for this is that under this condition there is a very high electric field between gate/field plates and the drain, which can cause defects in the dielectric and eventually result in a catastrophic failure between the field plate and drain.

Figure 2 Defect formation in high field region [10] which eventually causes the device to fail

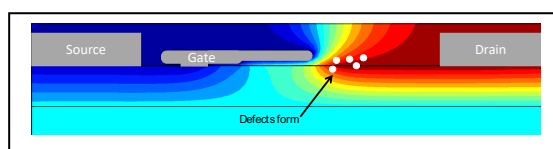
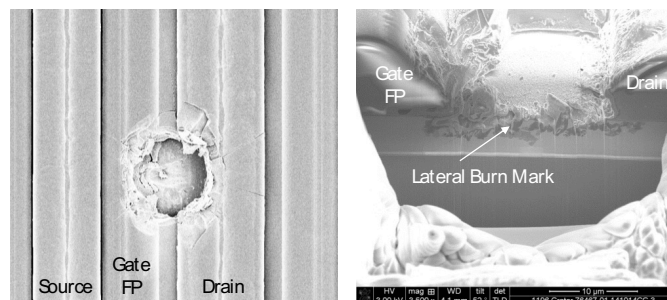

Figure 3 Crater formation between field plate and drain, typical failure mode (overhead and cross sectional views)



This failure mode dominates the off state failures regardless if the failure is caused by voltage or temperature acceleration. It shows up as wear out failure (intrinsic) and also shows up as infant mortality failures (extrinsic) defect moderated failures as well. The most likely explanation for early defects sharing the same failure mode as the intrinsic defects is that defects in the wafer from the fabrication process accumulate charge and accelerate failure of the device in the region around the defect due to changes in the electric field.

Voltage and temperature acceleration factors for this failure mode have been calculated [10]. A detailed review of the methodology is beyond the scope of this paper but follows is a summary of the test.

Voltage acceleration was determined by testing to failure a sample of material at voltages between 1050V – 1300V.

Figure 4: Voltage Acceleration Factor

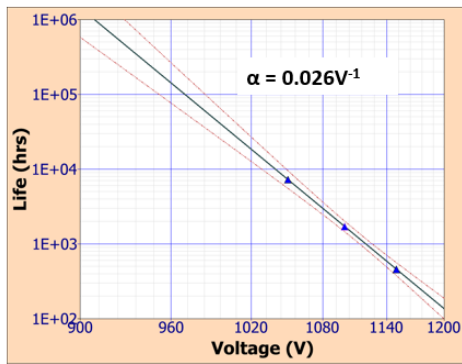

A linear TDDDB (time dependent dielectric breakdown) model was used, which is a conservative model relative to ttf (time to fail). In other words this model results in the shortest lifetime. The Voltage Acceleration Factor (AF_V) is defined in (1), where ΔV is the difference between the stress voltage and the usage voltage.

$$AF_V = e^{-(a\Delta V)} \quad (1)$$

Temperature acceleration factor (AF_T) assumes an Arrhenius relationship and was generated by testing parts to failure at -20° to +150° C at voltages ranging between 1050V and 1300V

Figure 5: Temperature acceleration factor for HVOS/HTRB

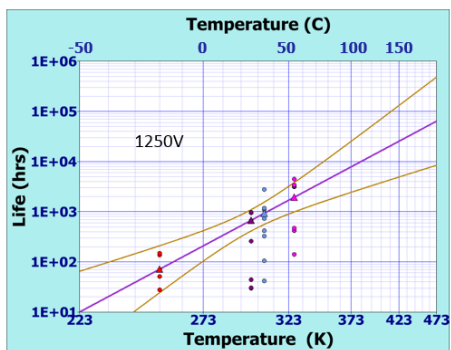

The slope of the plot as analyzed with Alta-pro software reveals the activation energy $E_a = -0.3eV$ and the acceleration factor is calculated with equation (2) as referenced. Note: k is the Boltzmann's constant. The combined acceleration factor AF is simply the product of the voltage and temperature acceleration factors (3) [3].

$$AF_T = \exp\left(\frac{E_a}{k} \left(\frac{1}{T_{use}} - \frac{1}{T_{stress}} \right)\right) \quad (2)$$

$$AF = AF_T * AF_V \quad (3)$$

IV. INTRINSIC FAILURE RATE

Use plot analysis gives a more complete picture of the intrinsic failure rate of the device by combining data from multiple wafers, and test and utilizing the acceleration factors previously derived [11].

Figure 6: Example Use plot

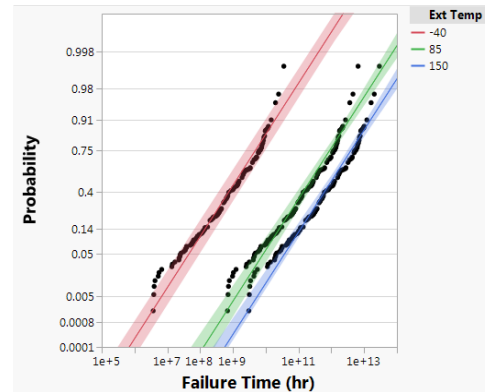

This use plot of the data which shows that even at -40°C @480V wear out of the device does not begin before 10^6 hours.

V. EARLY LIFE (EXTRINSIC)FAILURE

Of course we may find that parts fail prior to their intrinsic lifetime due to defects that are not screened out during the manufacturing process. These can include infant mortality as well as random failures during the useful life of the part (the time before the part wears out). From a practical concern what we really want to know is how many parts are going to fail in the first 10^5 hours (~10 years) for a given mission profile. Depending on warranty considerations an understanding of early failure rate can be very important. The methods used in this report are based upon JEDEC standards [8] and are well established.

A. High voltage acceleration testing

Silicon MOSFETs typically avalanche at high voltage, which makes using voltage as an acceleration factor problematic. While it can be useful to evaluate avalanche reliability, there are clearly two different reliability "regimes" in silicon devices, avalanche and non-avalanche reliability. GaN devices do not avalanche. Instead they experience increased leakage with voltage and eventual TDDB type breakdown. In general GaN can breakdown in one of two ways. Either laterally from the gate/field plate structure to the

drain, or vertically, through the insulating layers formed by doping the underlying GaN buffer layer. This is a basic design consideration and could vary from manufacturer to manufacturer. Transphorm's 650V part breaks down at over 1300V, vertically by design. High voltage breakdown has a positive activation energy (as shown in the graph). This is fundamentally different from HTRB/HVOS type failures which have a negative activation energy and fail laterally.

Figure 7: Vertical leakage versus temperature

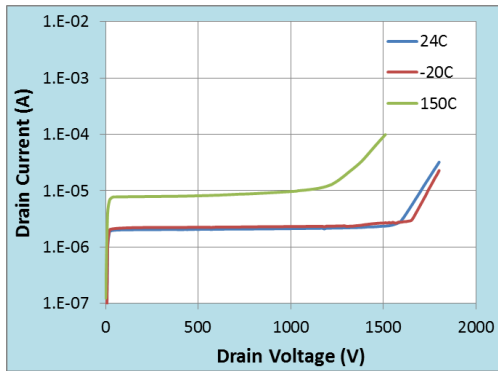

Product robustness to high voltage enables testing to failure using voltage acceleration, which will improve the validity of our reliability tests. By keeping the accelerating voltage below the breakdown we are able to limit the device failure to a single dominate failure mode, which is a lateral breakdown of the device in the high field region, caused by degradation of the dielectric due to impact ionization [10]. As long as voltages below vertical breakdown are used for reliability studies we can assume that the field driven lateral breakdown is dominant.

The fact that we are able to use voltage acceleration to model our device reliability enables us to create a two dimensional reliability table. Whereas most Si MOSFETs publish reliability against temperature, Transphorm reliability tables are a matrix between Voltage and Temperature.

B. MTBF, PPM, FIT definitions and considerations

1) MTBF (Mean Time Between Failures)

When reliability is reported in terms of MTBF the underlying assumption is that we have a constant failure rate, and are at the “bottom” of the bath tub curve. This also implies that we are in the useful life period of the product’s life cycle, between infant mortality and wear out. This seems to be a simple and straightforward means of assessing reliability risk, and it is very useful as long as one is not lulled into complacency by a lack of understanding of what MTBF means. (Note: for non-repairable systems MTBF = MTTF)

The best way to demonstrate is by example. Keep in mind that MTBF is an *AVERAGE* value. It is not the time to FIRST FAILURE!! So in order to make use of MTBF we must translate that value into something more useful, which could be the % failures during the parts useful life. It turns out that there is a simple equation (4) which calculates the percentage of

parts remaining, given a constant failure rate (MTBF) and a time interval *t*. [12].

$$\text{Percent Remaining} = e^{-t/MTBF} \tag{4}$$

Now for our example: A 100 year MTBF seems like “plenty of margin” if we want our device to survive 10 years in the field. So we use equation (4) to calculate the annual failure rate: the percentage surviving after 10 years would be

$$\text{Proportion Surviving: } e^{-10/100} = 90.05\%$$

This would be a loss rate over 1% per year, which of course would be a disaster in the field.

This is why MTBF values for mature technologies always seem absurdly large. In actuality they are not absurd if one requires field failure rates approach .01% or .001% per year. The following figure illustrates this relationship:

Figure 8 Annual %Failure vs MTBF in Years

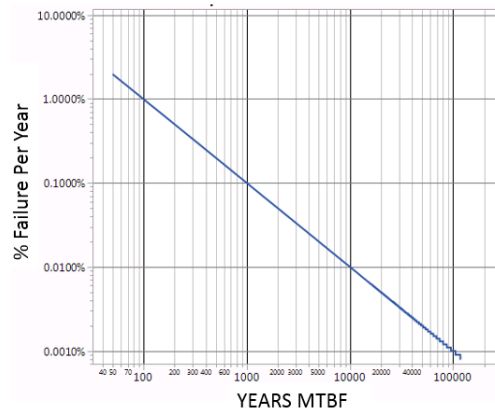

As an example 0.01% annual failure rate implies an MTBF of 10,000 years.

2) FIT (Failures in Time) or (Failures per Billion Device Hours)

FIT calculations also assume that we are in the flat part of the bathtub curve. In fact FIT and MTBF are completely interchangeable with a simple conversion: $FIT = 10^9/MTBF_{\text{hours}}$ as illustrated in the following figure. Typically semiconductor devices have FIT rates from 1-300 depending on conditions. To achieve a 0.01% annual failure rate we need a FIT ≈ 11 . Automotive applications demand FIT closer to one, or 0.001% annual failure rates.

Figure 9 Annual % Failure vs FITs

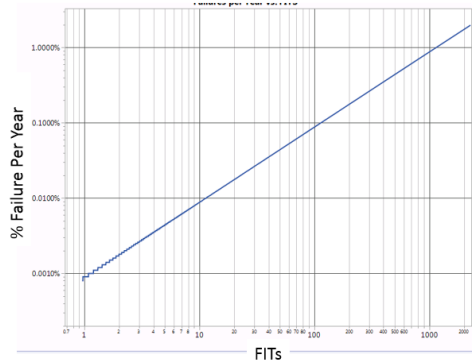

3) PPM (Parts per Million)

In the context of product reliability PPM quality levels are fundamentally different from MTBF or FIT calculations which are defined in JEDEC documentation [8]. FIT and MTBF calculations assume a constant failure rate. PPM calculations assume that we are the early failure portion of the bathtub curve, which assumes a failure rate that is **decreasing with time, and is being influenced by infant mortality** and can be modeled with a Weibull distribution with a shape parameter (m) less than one. The other important thing to keep in mind about PPM is that it must be related to a specific time period. PPM is just another way of saying proportion failed, and is meaningless without a time context. Unless otherwise noted in this paper PPM refers to PPM per year (which is common practice). 8.76 PPM/Year is equivalent to 1 FIT [12]. For the purposes of this report we will follow the convention in the JEDEC standard and refer to FIT for constant failure rate and PPM for decreasing failure rate [8]

VI. PPM TESTING

A. Experimental Design

In order to determine the Weibull shape parameter we need to generate sufficient numbers of infant mortality failures to enable us to fit a distribution to the data. Because wafer probe (prepackage test) is specifically designed to weed out infant mortality failures these tests must be bypassed when creating the sample for PPM testing.

A sample of 1200 parts (with critical tests skipped) was created and then subjected high voltage, off state stress, similar to HTRB type testing, except that these tests were run at 800V (which is significantly greater than the rated voltage (650V) for this part. Tests were conducted at 85C. The parts were stressed for a total of 500 hours with parts removed and tested every 24 hours, until the last 100 hours of the test which had no failures.

Figure 10: PPM Weibull plot

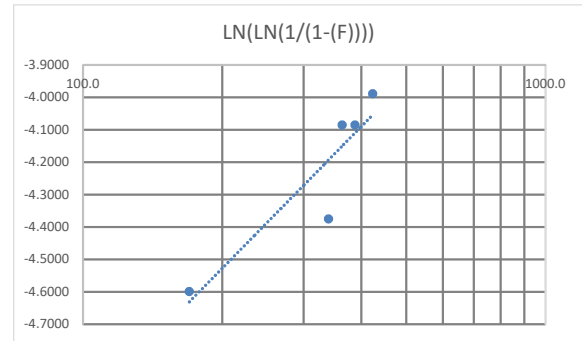

Data was fitted to the Weibull distribution using JMP Software (version 13) using Maximum Likelihood. The shape parameter $m = 0.74$. This value for the shape parameter will then be used to calculate the PPM quality level, as follows in this document.

All failed parts were de-capsulated and inspected to ensure that all had the same failure mode.

B. Mission Profile Used for life test

For the purposes of this study we did not use any specific mission profile. Instead we assume lifetime directly related to off state voltage and temperature. Of course lifetime is directly related to voltage and temperatures used, and Transphorm publishes FIT rates as a matrix so to better aid the design engineer. Just as “shorthand” when we refer to typical use conditions we will use 480V/100C.

C. PPM Data Summary

In order to test for PPM levels it is preferable to test large samples of parts, at accelerated conditions until at least some parts in the sample fail. These parts were drawn from standard production, and have had their complete set of in process electrical tests and quality screens. Of course whenever one is accelerating failures one must take care to ensure that the failures are representative of what we would see in normal use conditions. Tests need to be conducted well below the breakdown region of the device, and at temperatures not too far outside of normal operating conditions. Also, while running all tests at the same temperature and voltage would simplify the calculations, there runs the risk of some “unknown” failure mode that might not be discovered (perhaps with a different activation energy). So parts were stressed at different voltage and temperature settings. The following tables shows the distribution of parts across voltages and temperatures. Also shown are the number of failures in each category. Most tests were run for 1000 hours, though there were a few tests run for shorter periods of time and some tests were extended up to 3000 hours. To generate this data Transphorm developed a circuit that can sense the exact time that a device failed, eliminating the need to use interval failure data, and greatly improving the accuracy of the model. In some cases data from different die are combined by adjusting the sample size by the die area. The number of failed die are *not* adjusted by the die area, which likely resulted in a slight over count of the failures in some cases. Data is normalized to the 50 mohm device.

Sample Size		Voltage			
		520	650	850	900
Temperature	25	250		20	133
	150	2378	880		
	175		240		
Failures		Voltage			
		520	650	850	900
Temperature	25	0		4	14
	150	0	0		
	175		0		

All failures occurred in the high voltage segment of the test.

This test represents $4.5 \cdot 10^{10}$ device hours at typical use conditions

D. PPM Calculations

All calculations follows the procedure documented in JEDEC Standard No 74A [8] Annex G

1. Definitions

- a. t_u : use time
- b. N: size of each test
- c. S: total sample size
- d. t_{UWA} : weighted use time
- e. f: # of failures
- f. c: confidence interval (60%)
- g. d: degrees of freedom
- h. χ^2 : chi square
- i. η_{WA} : weighted average characteristic time
- j. tELF: early life period (hours)
- k. ELFR: early life failure rate in PPM/Year
- l. FIT: Failures in time

2. Calculate acceleration factors for each set of conditions using equations (1), (2), (3) of this report

3. Assume 60% confidence interval (standard practice) for χ^2 for given degrees of freedom = $(2f)+2$ (5)

$$4. t_{U_i} = AF * \text{Test Duration (per condition)} \quad (6)$$

$$5. S = \text{total sample count for all tests} \quad (7)$$

$$6. t_{UWA} = \{\sum(N_i * t_{U_i})\} / S \quad (8)$$

$$7. \eta_{WA} = t_{UWA} / \{-\ln[1 - \chi^2 / (2 * S)]\}^{1/m} \quad (9)$$

$$8. PPM = 1 - \exp[-(tELF / \eta_{WA})^m * 10^6] \quad (10)$$

The PPM calculation decreases with time due to the nature of the Weibull distribution and is meant to represent failures in the field, due to infant mortality escapes from the reliability screening process. So that we can compare the annual failure rate of PPM calculations reasonably with the FIT calculations in the following section, we will calculate the PPM for a period of 10 years, then report the per year PPM as the average value.

Average PPM		Voltage		
		400	480	520
Temp	25	16.8	78.6	169.5
	50	8.6	40.3	86.8
	100	3.0	13.8	29.8
	150	1.3	6.1	13.2
Average MTBF		Voltage		
		400	480	520
Temp	25	5E+08	1E+08	5E+07
	50	1E+09	2E+08	1E+08
	100	3E+09	6E+08	3E+08
	150	7E+09	1E+09	7E+08
Average Annual Failure Rate		Voltage		
		400	480	520
Temp	25	0.001680%	0.007860%	0.016949%
	50	0.000860%	0.004030%	0.008680%
	100	0.000300%	0.001380%	0.002980%
	150	0.000130%	0.000610%	0.001319%

From the average PPM we can then calculate the Average MTBF

$$8.76 * 10^9 / \text{Average PPM} = \text{Average MTBF} \quad (11)$$

From the MTBF we can then calculate the average annual failure rate via equation (4).

In general this is a pessimistic view of the data as the assumption behind it is that the infant mortality related failures have not been screened out and continue to fail in the field. Even with this pessimistic view of the data the model predicts an average failure rate under typical use conditions (480V/100C) of .001%.

A basic question to be answered, then, are we in the early failure region of the bathtub curve, or are we in the constant failure rate portion of the bathtub curve.

VII. DETERMINING IF WE ARE IN THE EXPONENTIAL REGION (CONSTANT FAILURE RATE)

It is common practice for device makers to “assume” that their product is in the constant failure rate portion of the bath tub curve, without any data to actually demonstrate that they are, and to calculate reliability assuming a shape parameter $m=1$. In order to determine if we are in the constant failure rate section of the bath tub curve we need to test parts to failure, then fit the appropriate Weibull distribution to the data. If the shape parameter, m , is near to one, then we can reasonably assume that we are in the constant failure rate period (bathtub curve bottom) and can model the failure rate using the exponential relationship, as is common practice.

The following figure shows time to failure for 900V/25C reliability test from the previous data. This data was used because it had the highest failure rate, and the largest number of failures. The shape parameter, $m = .99$, (as modeled on JMP software) which demonstrates that the high voltage screens used during production is removing the infant mortality failures.

IX. SUMMARY AND CONCLUSIONS

JEDEC, AEC, and ZVEI have published a comprehensive library of standards that can be used to characterize the reliability of wide band gap electronics today. Transphorm has conducted extensive tests on its products, following the relevant standards and can demonstrate reliability on par with and superior to existing silicon and other wide band gap technologies.

REFERENCES

- [1] JESD 47H.01 Stress Test Driven Qualification of Integrated Circuits
- [2] AEC Q101 Rev D1 Failure Mechanism Based Stress Qualification for Discrete Semiconductors in Automotive Applications
- [3] JESD85 Methods for Calculating Failure Rates in Units of FITs
- [4] JESD91A Method for Developing Acceleration Models for Electronic Component Failure Mechanisms
- [5] How to Measure Lifetime for Robustness Validation ZVEI 2012
- [6] Robustness Validation Manual ZVEI 2014
- [7] Handbook for Robustness Validation of Semiconductor Devices in Automotive Applications ZVEI 2015
- [8] JESD74A Early Life Failure Calculation Procedure for Semiconductor Components
- [9] <https://www.transphormusa.com/en/product/tph3205wsbqa-2/>
- [10] ROCS 2017
- [11] K. Smith et al, Microelectronics Reliability 58(2016)197-203
- [12] Improving Product Reliability: Strategies and Implementation. Mark A Levin and Ted T. Kalal, 2003 John Wiley 7 Sons, Ltd, ISBN: 0-470-85449-9, pages 299 to 306

Figure 11 Weibull Probability Plot of 900V Data

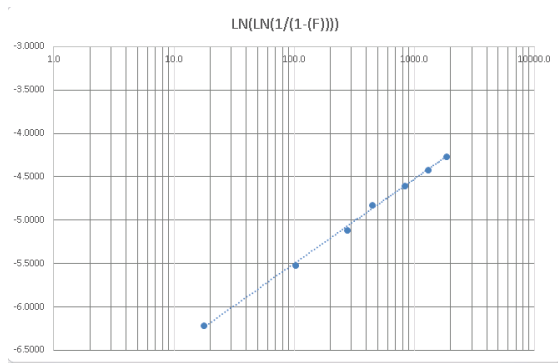

Based on this calculation is reasonable to assume that we are in the “bottom” of the bathtub curve, and can use this assumption in calculating FIT rates.

VIII. FIT CALCULATION

There are two methods for calculating FIT rates in JESD Standard #74 [8]. There is a simple method in Annex C, or one can simply set the Weibull shape parameter $m=1$, and then repeat the previous set of calculations, (5) – (10). (The Weibull distribution reduces to the exponential when $m=1$) The results are the same regardless and are as follows: (using the same data that was used for the earlier PPM calculations)

FIT		Voltage		
		400	480	520
Temp	25	0.58	4.68	13.18
	50	0.24	1.89	5.33
	100	0.06	0.45	1.26
	150	0.02	0.15	0.42
MTBF		Voltage		
		400	480	520
Temp	25	2E+09	2E+08	8E+07
	50	4E+09	5E+08	2E+08
	100	2E+10	2E+09	8E+08
	150	6E+10	7E+09	2E+09
Annual Failure Rate		Voltage		
		400	480	520
Temp	25	0.000510%	0.004095%	0.011541%
	50	0.000207%	0.001651%	0.004672%
	100	0.000049%	0.000390%	0.001102%
	150	0.000016%	0.000129%	0.000365%

Data shows very good reliability, and very low failure rates consistent with automotive requirements. The FIT calculation is lower than the PPM calculation for typical use case (.0004% versus .001%) which shows the importance of actually testing enough parts to failure to determine if, in fact, one is in the constant failure rate section of the bathtub curve, or if one is still experiencing some level of infant mortality failures.

This method of using FIT calculations, and assuming $m=1$ is common practice in the semiconductor industry.

This data demonstrates the effectiveness of the testing methodology that is used during production, to screen out defects that could cause early life failures.